

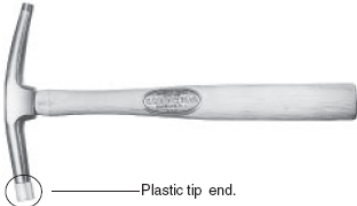

Tools Catalog

Product Picture	Name	Description
Hammers and Mallets		
	7 oz. Head Bronze Magnetic Hammer	Osborne No. 33 Solid head of bright bronze. Steel tipped at one end for permanent magnet and at the other for hammering. Balanced design, shellacked hardwood handle. <i>(Head Length: 5 1/2 inches; Head Weight: 7 ounces; Magnetic Face: 1/4 inches; Large Face: 7/16 inches; Weight: 11 ounces; UPC No. 56042)</i>
 <p>Plastic tip end.</p>	Nylon Tip Magnetic Hammer for Decorative Nails	Osborne No. 36 This hammer is similar to our popular No. 33 magnetic hammer but the large face is fitted with a nylon tip. This prevents damage to ornamental nails. <i>(Head Length: 5 1/2 inches; Head Weight: 6 ounces; Magnetic Face: 1/4 inches; Large Face: 7/16 inches; Weight: 11 ounces; UPC No. 56072)</i> <i>Nylon tips also available separately. Part No. 36-T UPC No. 56076</i>
	Replacement Handles	Osborne No. 33-H Replacement handles for above hammers: 33 and 36. <i>UPC No. 56046. Wedge included</i>

Sign up for our monthly e-mail newsletter to receive SPECIAL DISCOUNTS!!

emaildiscounts@handrfabrics.com



H & R Fabrics
1118 North 35th Ave.
Phoenix, Arizona 85009

Mon. - Fri. 8:00 - 5:30
Saturday 9:00 - 2:00
Closed Sunday

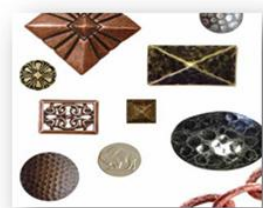
602.269.6131
www.handrfabrics.com



Tools Catalog

Product Picture	Name	Description
	Ripping Hammer	Osborne No. 277 1/2 Forged tool steel, balanced and tough. Double edged at right angles for stripping off old fabric. A favorite with upholsterers. <i>(Head Length: 5 inches; Width of Bits: 13/16 inches; Weight: 1 1/4 pounds; UPC No. 56162)</i>
	Rawhide Mallet	Osborne No. 196 The head of this lightweight mallet is made entirely of rolled water buffalo rawhide. Handle is white hickory. It is recommended for many jobs where the user wishes to avoid scarring. <i>(Size No.: 2 1/2; Face Diameter: 2 3/8 inches; Head Length: 5 1/2 inches; Overall Length: 10 1/2 inches; Weight: 16 ounces; UPC No. 61014)</i>
	Barrel Shaped Hickory Mallet	Osborne No. 89.5 Made of hickory, a carefully finished, well balanced, heavy mallet. Lacquered. <i>(Size No.: 2 1/2; Face Diameter: 2 3/8 inches; Head Length: 5 1/2 inches; Overall Length: 10 1/2 inches; Weight: 16 ounces; UPC No. 61014)</i>

Sign up for our monthly e-mail newsletter to receive SPECIAL DISCOUNTS!!

emaildiscounts@handrfabrics.com



H & R Fabrics
 1118 North 35th Ave.
 Phoenix, Arizona 85009

Mon. - Fri. 8:00 - 5:30
 Saturday 9:00 - 2:00
 Closed Sunday

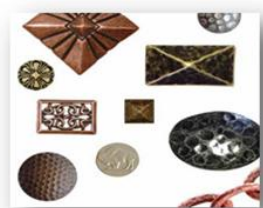
602.269.6131
www.handrfabrics.com



Tools Catalog

Product Picture	Name	Description
	<p>Black Rubber Mallet</p>	<p>Osborne No. 197</p> <p>Rubber mallets can be used without fear of marring metal parts. Limited bounce. Head of solid dense black rubber with white hardwood handle.</p> <p><i>(Size No.: 2; Face Diameter: 2 inches; Head Length: 3 1/4 inches; Overall Length: 12 inches; Weight: 11 ounces; UPC No. 61162)</i></p> <p><i>(Size No.: 3; Face Diameter: 2 1/2 inches; Head Length: 4 1/2 inches; Overall Length: 14 inches; Weight: 24 ounces; UPC No. 61164)</i></p>
Staple/Tack Tools		
	<p>Staple Lifter</p>	<p>Osborne No. 120 1/2</p> <p>The correct angle for removing staples of any size, from the smallest to the long leg staples and shredded material. Manufactured from top grade steel. Electronically hardened working ends are oven tempered to avoid breakage. Multisided handle to keep from rolling, made of easy to grip amber plastic. A very popular model. Not recommended for pulling out tacks.</p> <p><i>(Blade Length: 4 1/2 inches; Overall Length: 6 1/2 inches; Weight: 4 ounces; UPC No. 64006)</i></p>

Sign up for our monthly e-mail newsletter to receive SPECIAL DISCOUNTS!!

emaildiscounts@handrfabrics.com





H & R Fabrics
1118 North 35th Ave.
Phoenix, Arizona 85009

Mon. - Fri. 8:00 - 5:30
Saturday 9:00 - 2:00
Closed Sunday

602.269.6131
www.handrfabrics.com



Tools Catalog

Product Picture	Name	Description
	Staple Remover	<p>Osborne No. 124</p> <p>Forged from 4140 alloy tempered steel. A consistently made Osborne quality product. Carefully hardened for lasting use.</p> <p><i>(Blade Length: 2 1/4 inches; Overall Length: 6 inches; Weight: 4 ounces; UPC No. 64014)</i></p>
	Tack and Staple Remover	<p>Osborne No. 121</p> <p>This staple and tack remover is constructed with the same honest craftsmanship that goes into all Osborne tools. Can also be used for grooving out drawers, so that when re-glued they will stick. Made of forged steel with wooden handle.</p> <p><i>(Blade Length: 2 1/2 inches; Overall Length: 6 1/2 inches; Weight: 2 ounces; UPC No. 64010)</i></p>
	Staple and Tack Claw	<p>Osborne No. 201</p> <p>A good quality drop forged tack claw. Pointed ends are hardened and tempered to prevent breakage. Traditional wooden handle. Flat base.</p> <p><i>(Blade Length: 2 1/2 inches; Overall Length: 7 inches; Weight: 4 ounces; UPC No. 64224)</i></p>
	Carded Tack Claw	<p>Osborne No. 146</p> <p>Drop forged 1/2 inch tempered steel blades. Polished black plastic handle. Carded on yellow background 8-1/2" x 3-1/2". Clear plastic wrapped.</p> <p><i>(Blade Length: 3 7/8 inches; Overall Length: 6 5/8 inches; Weight: 3 ounces; UPC No. 64216)</i></p>

Sign up for our monthly e-mail newsletter to receive SPECIAL DISCOUNTS!!
emaildiscounts@handrfabrics.com

H & R Fabrics
 1118 North 35th Ave.
 Phoenix, Arizona 85009

Mon. - Fri. 8:00 - 5:30
 Saturday 9:00 - 2:00
 Closed Sunday

602.269.6131
www.handrfabrics.com

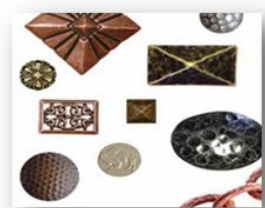

Tools Catalog

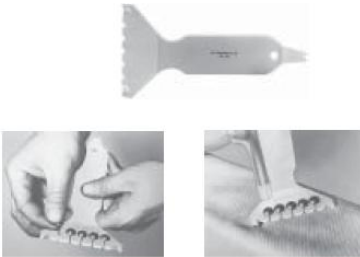
Product Picture	Name	Description
	Staple Lifter	<p>Osborne No. 1066</p> <p>Polished and forged steel blade. Hardwood handle. A European favorite.</p> <p><i>(Blade Length: 3 5/8 inches; Overall Length: 8 inches; Weight: 3 ounces; UPC No. 64018)</i></p>
	Antique Nail Pliers	<p>Osborne No. 601</p> <p>Hardened steel, top quality. Very convenient size for removing antique nails.</p> <p><i>(Length: 7 inches; Width: 1 3/4 inches; Weight: 6 ounces; UPC No. 54212)</i></p>
	Quick Nailer	<p>Osborne No. 777</p> <p><u>FANCY NAIL SPACER FOR SPACING ANTIQUE NAILS.</u> Set up to 5 nails head to head at one time without damaging the furniture, or your fingers. Exact spacing at the same time! Load large end of tool making sure nails are perpendicular to and shanks are flush with base of tool. Position tunneled section of tool over last nail driven and being setting nail. Removal of tool may require twisting motion and/or pressure against nail heads with free hand. Use Osborne No. 36 Nylon tip hammer for best results. Patent No. 4079764.</p> <p><i>(Overall Length: 7 inches; End Width: 3 1/2 inches; Weight: 2 ounces, UPC No. 64502)</i></p>

Stretchers, Specialty Pliers, and Cutting Nippers

Sign up for our monthly e-mail newsletter to receive *SPECIAL DISCOUNTS!!*

emaildiscounts@handrfabrics.com

H & R Fabrics
 1118 North 35th Ave.
 Phoenix, Arizona 85009

Mon. - Fri. 8:00 - 5:30
 Saturday 9:00 - 2:00
 Closed Sunday

602.269.6131
www.handrfabrics.com

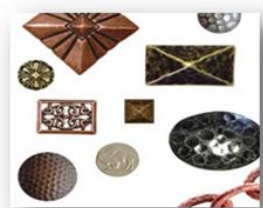

Tools Catalog

Product Picture	Name	Description
	Webbing Stretcher (Rubber End)	<p>Osborne No. 255</p> <p>Webbing stretcher made of hardwood maple with corrugated rubber at one end, and one row of 6 sharpened steel pins at other end.</p> <p><i>(Length: 8 inches; Width: 3 1/4 inches; Weight: 8 ounces; UPC No. 64268)</i></p>
	Gooseneck Webbing Stretcher	<p>Osborne No. 253</p> <p>A hand stretcher to catch the webbing close to the frame with plenty of leverage. Equally efficient for right or left hand. Extra sturdy construction. Approved favorite.</p> <p><i>(Length: 10 inches; Width: 4 inches; Weight: 14 ounces; UPC No. 64266)</i></p>
	Blind Stitching Seam Stretcher	<p>Osborne No. 267</p> <p>Made of light aluminum, simple toggle clamp construction. Easy to operate. Minimum length 12" for pillows, maximum length 3 ft. Rigid when in use. Can also be used as calipers for cutting large circles and for blind stitching. Easy to follow instructions on each package. Points easily replaced high quality tool.</p> <p><i>(Overall Length: 40 inches; Weight: 12 ounces, UPC No. 64276)</i></p>

Sign up for our monthly e-mail newsletter to receive SPECIAL DISCOUNTS!!

emaildiscounts@handrfabrics.com



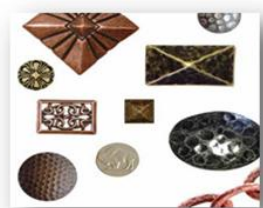

H & R Fabrics
1118 North 35th Ave.
Phoenix, Arizona 85009

Mon. - Fri. 8:00 - 5:30
Saturday 9:00 - 2:00
Closed Sunday

602.269.6131
www.handrfabrics.com



Tools Catalog

Product Picture	Name	Description
	Webbing, Canvas Pliers	<p>Osborne No. 250</p> <p>Made with hammer jaw, the hammer acts as a lever if a strong pull is required. Excellent tool for stretching canvas and leather as well as webbing.</p> <p><i>(Length: 8 1/2 inches; Width: 3 3/8 inches; Weight: 18 ounces; UPC No. 54042)</i></p>
	Spring Clip Pliers	<p>Osborne No. 445-3</p> <p>Special pliers for three prong setting spring or edge wire clips. A great saver. No. 445 regular sets Kay or Baker clips.</p> <p><i>(Length: 7 inches; Weight: 2 ounces; UPC No. 54222)</i></p>
	Diagonal Cutting Nippers	<p>Osborne No. 91</p> <p>These rugged drop forged nippers are ideal for cutting hog rings and wire. Polished head, black handles, finest industrial quality. Red plastic grips.</p> <p><i>(Length: 7 3/8 inches; Weight: 9 ounces; UPC No. 54082)</i></p>
	End Cutting Nipper	<p>Osborne No. 94</p> <p>An excellent small nipper. Made of drop forged steel. Black finish, polished jaws. Flush cut.</p> <p><i>(Length: 6 3/8 inches; Weight: 7 ounces; UPC No. 54122)</i></p>
Auto Trim Tools		

Sign up for our monthly e-mail newsletter to receive SPECIAL DISCOUNTS!!

emaildiscounts@handrfabrics.com

H & R Fabrics
1118 North 35th Ave.
Phoenix, Arizona 85009

Mon. - Fri. 8:00 - 5:30
Saturday 9:00 - 2:00
Closed Sunday

602.269.6131
www.handrfabrics.com

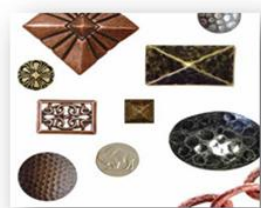

Tools Catalog

Product Picture	Name	Description
	Headrest Release Keys Set	Osborne No. K-752 Set of 4 Headrest Release Keys No. 752's. Perfect for auto trim work. 1 each of following sizes Osborne No. 752 Headrest Release Keys. <i>(Sizes: 1/4, 3/8, 1/2, 5/8 inches; Weight: 4 1/2 pounds; UPC No. 14722)</i>
	Door Handle Clip Remover	Osborne No. 758 High quality. Perfect for auto trim work. Plated. An industry standard. <i>(Length: 7 inches; Weight: 4 ounces; UPC No. 64764)</i>
	Moulding Release Key	Osborne No. 757 High quality. Perfect for auto trim work. Plated. An industry standard. <i>(Length: 7 inches; Weight: 4 ounces; UPC No. 64762)</i>
	Trim Pad Remover	Osborne No. 760 High quality. Perfect for auto trim work. Plated. An industry standard. <i>(Length: 8 1/2 inches; Weight: 4 ounces; UPC No. 64766)</i>

Sign up for our monthly e-mail newsletter to receive SPECIAL DISCOUNTS!!

emaildiscounts@handrfabrics.com



H & R Fabrics
 1118 North 35th Ave.
 Phoenix, Arizona 85009

Mon. - Fri. 8:00 - 5:30
 Saturday 9:00 - 2:00
 Closed Sunday

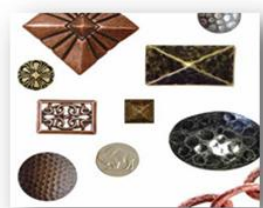
602.269.6131
www.handrfabrics.com



Tools Catalog

Product Picture	Name	Description
	Tucking Tool	<p>Osborne No. 747 RIGID</p> <p>For tucking headlining and upholstery around windows and above doors and other hard to reach places. A sturdy tough tool with a slightly curved blade that has finished edges and rounded corners. Comfortable wood handle with eyelet hole through one end.</p> <p><i>(Blade Length: 2 5/8 inches; Overall Length: 7 1/2 inches; Weight: 4 ounces; UPC No. 64704)</i></p> <p>Osborne No. 746 FLEXIBLE</p> <p>Same as above but with flexible spring steel blade. A very popular tool.</p> <p><i>(UPC No. 64702)</i></p>
 <p style="text-align: center;">NOSPRING</p>	Hog Ring Pliers with Vinyl Handles (no spring)	<p>Osborne No. 1440</p> <p>Three different styles with straight or angled handles, comes with no springs. Please specify style. Grooves are the proper depth. Jaws and handles are aligned. Made of forged steel and vinyl handles. Each one weighs eight ounces. Works with Osborne hog rings No.1442 and 1443. Please specify style when ordering.</p> <p>1440-A Straight handles 6 3/4 inches long 1440-B Handles bent at 135 degrees angle to jaw 1440-C Handles bent to reach difficult spots</p> <p><i>(Osborne No.: 1440-A; Type: No spring; UPC No. 54132)</i> <i>(Osborne No.: 1440-B; Type: No spring; UPC No. 54138)</i> <i>(Osborne No.: 1440-C; Type: No spring; UPC No. 54144)</i></p>

Sign up for our monthly e-mail newsletter to receive SPECIAL DISCOUNTS!!

emaildiscounts@handrfabrics.com

H & R Fabrics
 1118 North 35th Ave.
 Phoenix, Arizona 85009

Mon. - Fri. 8:00 - 5:30
 Saturday 9:00 - 2:00
 Closed Sunday

602.269.6131
www.handrfabrics.com



Tools Catalog

Product Picture	Name	Description
	<p>Hog Ring Pliers with Vinyl Handles</p> <p>(closing spring)</p>	<p>Osborne No. 1440</p> <p>Three different styles with straight or angled handles, comes with closing springs. Please specify style. Grooves are the proper depth. Jaws and handles are aligned. Made of forged steel and vinyl handles. Each one weighs eight ounces. Works with Osborne hog rings No.1442 and 1443. Please specify style when ordering.</p> <p>1440-A Straight handles 6 3/4 inches long 1440-B Handles bent at 135 degrees angle to jaw 1440-C Handles bent to reach difficult spots</p> <p>(Osborne No.: 1440-AC; Type: Closing spring; UPC No. 54136) (Osborne No.: 1440-BC; Type: Closing spring; UPC No. 54142) (Osborne No.: 1440-CC; Type: Closing spring; UPC No. 54148)</p>
<p>Spring Tools</p>		

Sign up for our monthly e-mail newsletter to receive SPECIAL DISCOUNTS!!

emaildiscounts@handrfabrics.com



H & R Fabrics
 1118 North 35th Ave.
 Phoenix, Arizona 85009

Mon. - Fri. 8:00 - 5:30
 Saturday 9:00 - 2:00
 Closed Sunday

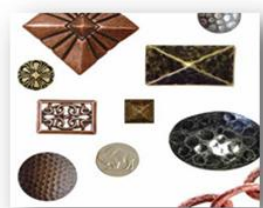
602.269.6131
www.handrfabrics.com

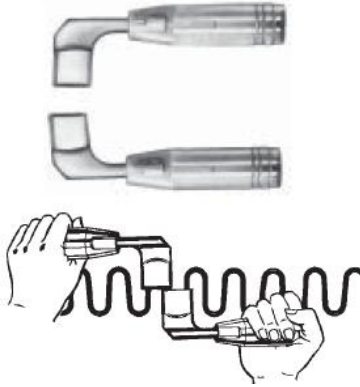

Tools Catalog

Product Picture	Name	Description
	<p>Spring Bender</p>	<p>Osborne No. 401</p> <p>Spring bender, which is both simple in application and efficient in use. Nickel plated ends are slotted to fit loops which can be bent with slight pressure or can be used to unbend previously made bends. This is precisely manufactured so that arcs, angles or curves can be properly made. Available in two sizes. Size two is not only used on auto seats but also on new furniture. Please specify size when ordering.</p> <p><i>(Size No.: 1; Size: 3/8 x 1 inches; Weight: 1 pound; UPC No. 14312)</i></p> <p><i>(Size No.: 2; Size: 3/8 x 2 inches; Weight: 2 pounds; UPC No. 14314)</i></p>
	<p>Spring End Former</p>	<p>Osborne No. 404</p> <p><u><i>Crimps the end of zig-zag springs and open end coil springs.</i></u></p> <p>A tough tool to make work easy. Comes with three bolts and nuts. Bolt to corner of bench or on a 1" block no more than 5" from edge of bench. Can be used in a vise. Drill 5/16" holes 1-3/4" apart.</p> <p><i>(Overall Length: 13 inches; Width: 1/2 inch; UPC No. 14322)</i></p>

Sign up for our monthly e-mail newsletter to receive SPECIAL DISCOUNTS!!

emaildiscounts@handrfabrics.com

H & R Fabrics
1118 North 35th Ave.
Phoenix, Arizona 85009

Mon. - Fri. 8:00 - 5:30
Saturday 9:00 - 2:00
Closed Sunday

602.269.6131
www.handrfabrics.com

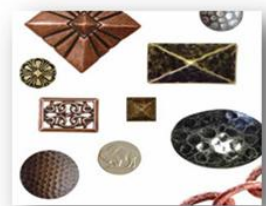

Tools Catalog

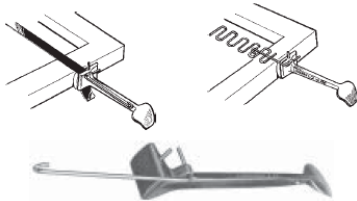
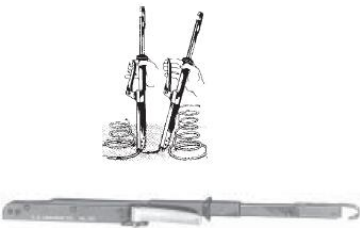
Product Picture	Name	Description
	Wire Former	<p>Osborne No. 1963</p> <p>A tough tool that makes difficult repairs easy. You can quickly bend the ends of no sags, edgewise and form springs right on the spot, making offsets where you need them. Can be readily mounted in a vise for duplicating complex repetitive wire bends. Designed with heat-hardened steel to give long live.</p> <p><i>(Overall Length: 21 inches; Width: 2 3/4 inches; Weight: 2 pounds; UPC No. 14651)</i></p>
	Metal Webbing Stretcher (4 in 1 Tool)	<p>Osborne No. 258</p> <p>A versatile all metal tool for stretching various types of metal webbing, sagless springs, punched straps, etc. Flat handle gives lots of leverage.</p> <p><i>(Overall Length: 9 1/2 inches; Width: 2 1/4 inches; Weight: 1 1/4 pounds; UPC No. 64270)</i></p>
	Klinch-It Tool	<p>Osborne No. 720</p> <p>Quick and easy to use. Klinch-it lowers your production cost and increases your production by speeding up one of the greatest time-consuming operations. It eliminates the slow, old fashioned method of sewing springs to the web base. Instead the springs are permanently fastened with sturdy steel clips.</p> <p>Easy to use instructions: Fill magazine with 2 strips of fasteners, hold tools upright, place nozzle over spring, press down so that prongs of the fastener pierce the webbing, then squeeze lever and fastening is finished.</p> <p><i>(Overall Length: 27 inches; Width: 2 inches; Weight: 3 3/4 pounds, UPC No. 14650)</i></p>

Sign up for our monthly e-mail newsletter to receive SPECIAL DISCOUNTS!!

emaildiscounts@handrfabrics.com



H & R Fabrics
1118 North 35th Ave.
Phoenix, Arizona 85009

Mon. - Fri. 8:00 - 5:30
Saturday 9:00 - 2:00
Closed Sunday

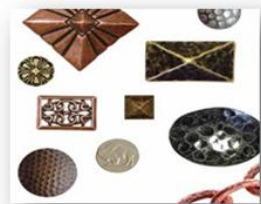
602.269.6131
www.handrfabrics.com



Tools Catalog

Product Picture	Name	Description
	Klinch-It Fasteners	<p>Osborne No. 7200</p> <p>Klinch-it fasteners to be used with our No. 720 Klinch-it tool. Made of high quality steel. Perfect fasteners for furniture use.</p> <p><i>(Packed 5000 per box; Weight: 8 1/2 pounds per box; UPC No. 14652)</i></p>
	Lever Spring Stretcher	<p>Osborne No. 268</p> <p>This sturdy tool is used for heavy duty installations and is a safe method for installing sinuous type springs. Just set spring into rear frame clip and then pull spring into position from the front of the frame</p> <p><i>(Overall Length: 17 1/2 inches; Handle Width: 1 inch; Weight: 10 ounces; UPC No. 64274)</i></p>
	Spring Puller Hook	<p>Osborne No. 297</p> <p>Can be used in conjunction with the No. 268 Lever Spring Stretcher or by itself.</p> <p><i>(Overall Length: 4 1/4 inches; Handle Width: 3 1/2 inches; Weight: 2 ounces; UPC No. 58242)</i></p>
Needles		

Sign up for our monthly e-mail newsletter to receive SPECIAL DISCOUNTS!!

emaildiscounts@handrfabrics.com

H & R Fabrics
1118 North 35th Ave.
Phoenix, Arizona 85009

Mon. - Fri. 8:00 - 5:30
Saturday 9:00 - 2:00
Closed Sunday

602.269.6131
www.handrfabrics.com

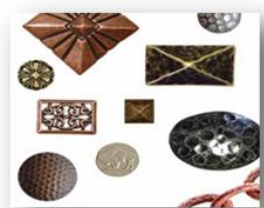

Tools Catalog

Product Picture	Name	Description
	Needle Card	<p>Osborne No. K-3</p> <p>Each card is composed of 4 round point needles in following sizes: 3", 4", 5" & 6".</p> <p><i>(Kits per box: 12, Weight per box: 6 ounces; UPC No. 15014)</i></p>
	Needle Card	<p>Osborne No. K-4</p> <p>Each card is composed of 4 diamond point needles in following sizes: 3", 4", 5" & 6".</p> <p><i>(Kits per box: 12, Weight per box: 6 ounces; UPC No. 15016)</i></p>
	Needle Card	<p>Osborne No. K-7</p> <p>Each card is composed of 4 round point extra light needles in following sizes: 2 1/2", 3", 3 1/2" & 4".</p> <p><i>(Kits per box: 12, Weight per box: 4 ounces; UPC No. 15020)</i></p>

Sign up for our monthly e-mail newsletter to receive SPECIAL DISCOUNTS!!

emaildiscounts@handrfabrics.com



H & R Fabrics
1118 North 35th Ave.
Phoenix, Arizona 85009

Mon. - Fri. 8:00 - 5:30
Saturday 9:00 - 2:00
Closed Sunday

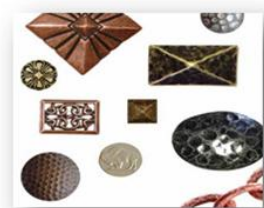
602.269.6131
www.handrfabrics.com



Tools Catalog

Product Picture	Name	Description
	<p>Curved Round Point</p>	<p>Osborne No. 501 1/2 Light</p> <p>1 dozen needles per package.</p> <p>(Size: 2 inches; Gauge: 19; UPC No. 15132) (Size: 2 1/2 inches; Gauge: 18; UPC No. 15134) (Size: 3 inches; Gauge: 18; UPC No. 15136) (Size: 3 1/2 inches; Gauge: 17; UPC No. 15138) (Size: 4 inches; Gauge: 16; UPC No. 15140) (Size: 5 inches; Gauge: 16; UPC No. 15142) (Size: 6 inches; Gauge: 15; UPC No. 15144) (Size: 7 inches; Gauge: 15; UPC No. 15146) (Size: 8 inches; Gauge: 15; UPC No. 15148)</p>
	<p>Curved Square Point</p>	<p>Osborne No. 502 1/2 Light</p> <p>1 dozen needles per package.</p> <p>(Size: 2 inches; Gauge: 19; UPC No. 15162) (Size: 2 1/2 inches; Gauge: 18; UPC No. 15164) (Size: 3 inches; Gauge: 18; UPC No. 15166) (Size: 3 1/2 inches; Gauge: 17; UPC No. 15168) (Size: 4 inches; Gauge: 17; UPC No. 15170) (Size: 5 inches; Gauge: 16; UPC No. 15172) (Size: 6 inches; Gauge: 16; UPC No. 15174) (Size: 7 inches; Gauge: 15; UPC No. 15176) (Size: 8 inches; Gauge: 15; UPC No. 15178)</p>

Sign up for our monthly e-mail newsletter to receive SPECIAL DISCOUNTS!!

emaildiscounts@handrfabrics.com



H & R Fabrics
 1118 North 35th Ave.
 Phoenix, Arizona 85009

Mon. - Fri. 8:00 - 5:30
 Saturday 9:00 - 2:00
 Closed Sunday

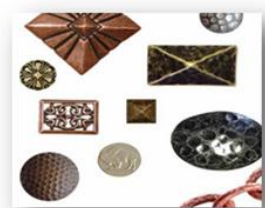
602.269.6131
www.handrfabrics.com



Tools Catalog

Product Picture	Name	Description
	Straight Single Round Point	Osborne No. 504 12 needles per package. <i>(Size: 4 inches; Gauge: 15; UPC No. 15362)</i> <i>(Size: 5 inches; Gauge: 14; UPC No. 15364)</i> <i>(Size: 6 inches; Gauge: 14; UPC No. 15366)</i> <i>(Size: 8 inches; Gauge: 14; UPC No. 15368)</i> <i>(Size: 10 inches; Gauge: 13; UPC No. 15370)</i> <i>(Size: 12 inches; Gauge: 13; UPC No. 15372)</i> <i>(Size: 14 inches; Gauge: 13; UPC No. 15374)</i> <i>(Size: 16 inches; Gauge: 12; UPC No. 15376)</i> <i>(Size: 18 inches; Gauge: 12; UPC No. 15378)</i>
	Straight Double Round Point	Osborne No. 505 12 needles per package. <i>(Size: 6 inches; Gauge: 14; UPC No. 15412)</i> <i>(Size: 8 inches; Gauge: 14; UPC No. 15414)</i> <i>(Size: 10 inches; Gauge: 13; UPC No. 15416)</i> <i>(Size: 12 inches; Gauge: 13; UPC No. 15418)</i> <i>(Size: 14 inches; Gauge: 13; UPC No. 15420)</i> <i>(Size: 16 inches; Gauge: 12; UPC No. 15422)</i> <i>(Size: 18 inches; Gauge: 12; UPC No. 15424)</i> <i>(Size: 20 inches; Gauge: 12; UPC No. 15426)</i>

Sign up for our monthly e-mail newsletter to receive SPECIAL DISCOUNTS!!

emaildiscounts@handrfabrics.com



H & R Fabrics
 1118 North 35th Ave.
 Phoenix, Arizona 85009

Mon. - Fri. 8:00 - 5:30
 Saturday 9:00 - 2:00
 Closed Sunday

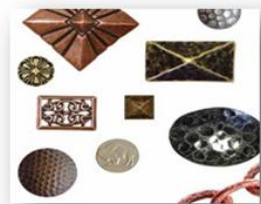
602.269.6131
www.handrfabrics.com



Tools Catalog

Product Picture	Name	Description
	Straight Single 3 Square Point	Osborne No. 506 12 needles per package. <i>(Size: 6 inches; Gauge: 14; UPC No. 15452)</i> <i>(Size: 8 inches; Gauge: 14; UPC No. 15454)</i> <i>(Size: 10 inches; Gauge: 13; UPC No. 15456)</i> <i>(Size: 12 inches; Gauge: 13; UPC No. 15458)</i> <i>(Size: 14 inches; Gauge: 13; UPC No. 15460)</i> <i>(Size: 16 inches; Gauge: 12; UPC No. 15462)</i> <i>(Size: 18 inches; Gauge: 12; UPC No. 15464)</i>
	Straight Double 3 Square Point	Osborne No. 507 12 needles per package. <i>(Size: 6 inches; Gauge: 14; UPC No. 15492)</i> <i>(Size: 8 inches; Gauge: 14; UPC No. 15494)</i> <i>(Size: 10 inches; Gauge: 13; UPC No. 15496)</i> <i>(Size: 12 inches; Gauge: 13; UPC No. 15498)</i> <i>(Size: 14 inches; Gauge: 13; UPC No. 15500)</i> <i>(Size: 16 inches; Gauge: 12; UPC No. 15502)</i> <i>(Size: 18 inches; Gauge: 12; UPC No. 15504)</i>

Sign up for our monthly e-mail newsletter to receive SPECIAL DISCOUNTS!!

emaildiscounts@handrfabrics.com

H & R Fabrics
 1118 North 35th Ave.
 Phoenix, Arizona 85009

Mon. - Fri. 8:00 - 5:30
 Saturday 9:00 - 2:00
 Closed Sunday

602.269.6131
www.handrfabrics.com

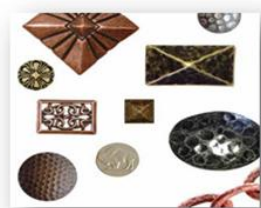

Tools Catalog

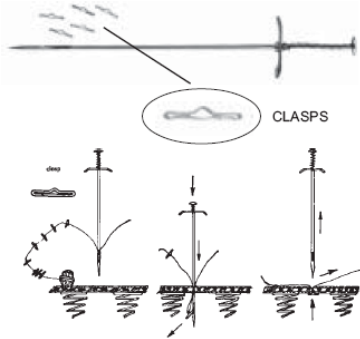
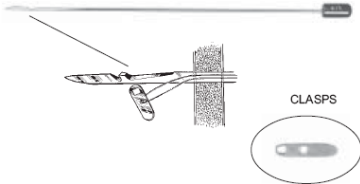
Product Picture	Name	Description
	<p>Tufting Needle and Clasps</p>	<p>Osborne No. 417 & 418</p> <p>THE VERY BEST. Does not catch when it is withdrawn. After threading button, end of needle is loaded with clasps. As needle reaches maximum depth, clasp is rejected. Saves time and labor. No need to remove the outside back of piece being tufted. A splendid tool to the true craftsman.</p> <p>Working Process: (Instructions are included with the tool.)</p> <ol style="list-style-type: none"> 1. At the start assemble on the thread the corresponding quantity of clasps for the required number of stitches. Insert clasp with thread in the hollow of the needle. 2. Push needle (with inserted clasps and thread) through upholstery fabric, press head of needle. Clasp with thread will be ejected. 3. Pull needle out and tighten thread, clasp will be anchored inside. <p>(No. 417 – Overall Length: 12 inches; Weight: 3 ounces; UPC No. 64386)</p> <p>(No. 418 – Each Per Box: 500; Weight: 10 ounces; UPC No. 14388)</p>
	<p>Tufting Needle and Clasps</p>	<p>Osborne No. 613 & 614</p> <p>Furniture button tufter comes with two dozen clips free. Osborne quality needle. Thread twine in round hole in clip, hook square hole on needle and, push then withdraw needle. Directions included.</p> <p>(No. 613 Needle – Overall Length: 12 inches; Gauge: 10; Weight: 2 ounces; UPC No. 64390)</p> <p>(No. 614 Clasps – Each Per Bag: 144; Weight: 5 ounces; UPC No. 14392)</p>

Leather Tools

Sign up for our monthly e-mail newsletter to receive SPECIAL DISCOUNTS!!

emaildiscounts@handrfabrics.com



H & R Fabrics
1118 North 35th Ave.
Phoenix, Arizona 85009

Mon. – Fri. 8:00 – 5:30
Saturday 9:00 – 2:00
Closed Sunday

602.269.6131
www.handrfabrics.com



Tools Catalog

Product Picture	Name	Description
	Belt Punch (round shank)	<p>Osborne No. 245</p> <p>Hardened cutting edge - milled clearing hole. Polished barrel. Widely used in the furniture industry. <u>Also available in millimeters sizes 2 to 20 mm.</u></p> <p><i>(Size No.: 00; Diameter: 1/16; Weight: 1 ounce; UPC No. 51460)</i> <i>(Size No.: 0; Diameter: 5/64; Weight: 1 ounce; UPC No. 51462)</i> <i>(Size No.: 1; Diameter: 3/32; Weight: 1 ounce; UPC No. 51464)</i> <i>(Size No.: 2; Diameter: 1/8; Weight: 1 ounce; UPC No. 51466)</i> <i>(Size No.: 3; Diameter: 9/64; Weight: 1 ounce; UPC No. 51468)</i> <i>(Size No.: 4; Diameter: 5/32; Weight: 1 ounce; UPC No. 51470)</i> <i>(Size No.: 5; Diameter: 11/64; Weight: 1 ounce; UPC No. 51472)</i> <i>(Size No.: 6; Diameter: 3/16; Weight: 1 ounce; UPC No. 51474)</i> <i>(Size No.: 7; Diameter: 13/64; Weight: 1 ounce; UPC No. 51476)</i> <i>(Size No.: 8; Diameter: 7/32; Weight: 1 ounce; UPC No. 51478)</i> <i>(Size No.: 9; Diameter: 1/4; Weight: 1 ounce; UPC No. 51480)</i> <i>(Size No.: 10; Diameter: 17/64; Weight: 3 ounces; UPC No. 51482)</i> <i>(Size No.: 11; Diameter: 9/32; Weight: 3 ounces; UPC No. 51484)</i> <i>(Size No.: 12; Diameter: 5/16; Weight: 3 ounces; UPC No. 51486)</i> <i>(Size No.: 13; Diameter: 11/32; Weight: 4 ounces; UPC No. 51488)</i> <i>(Size No.: 14; Diameter: 3/8; Weight: 4 ounces; UPC No. 51490)</i> <i>(Size No.: 15; Diameter: 13/32; Weight: 4 ounces; UPC No. 51492)</i> <i>(Size No.: 16; Diameter: 7/16; Weight: 4 ounces; UPC No. 51494)</i> <i>(Size No.: 1/2; Diameter: 1/2; Weight: 7 ounces; UPC No. 51496)</i> <i>(Size No.: 9/16; Diameter: 9/16; Weight: 9 ounces; UPC No. 51500)</i> <i>(Size No.: 5/8; Diameter: 5/8; Weight: 9 ounces; UPC No. 51498)</i></p>
	Revolving Punch (nickel plated)	<p>Osborne No. 223</p> <p>A fine quality pressed frame revolving punch with drive tubes. All tubes are heat treated to give long wear. Furnished with tubes sizes: 0 (5/64"), 1 (3/32"), 2 (7/64"), 3 (1/8"), 4 (5/32") & 6 (3/16"). Packaged on hang up blister packed board 11" x 4".</p> <p><i>(Overall Length: 8 1/2 inches; Weight: 6 ounces; UPC No. 02290)</i></p>

Sign up for our monthly e-mail newsletter to receive SPECIAL DISCOUNTS!!

emaildiscounts@handrfabrics.com

H & R Fabrics
1118 North 35th Ave.
Phoenix, Arizona 85009

Mon. - Fri. 8:00 - 5:30
Saturday 9:00 - 2:00
Closed Sunday

602.269.6131
www.handrfabrics.com

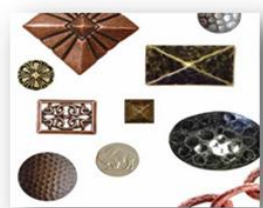

Tools Catalog

Product Picture	Name	Description
	Heavy Duty Scratch Awl	<p>Osborne No. 4</p> <p>Made in four sizes for your convenience. Best quality steel blades with rugged amber translucent plastic handles.</p> <p><i>(Size No.: 1; Blade Length: 2 1/2 inches; Weight: 1 ounce; UPC No. 62012)</i></p> <p><i>(Size No.: 2; Blade Length: 3 1/2 inches; Weight: 2 ounces; UPC No. 62014)</i></p> <p><i>(Size No.: 3; Blade Length: 4 1/2 inches; Weight: 3 ounces; UPC No. 62016)</i></p> <p><i>(Size No.: 4; Blade Length: 5 1/2 inches; Weight: 4 ounces; UPC No. 62018)</i></p>
	Automatic Awl	<p>Osborne No. 413</p> <p>An excellent tool for sewing leather, canvas and similar materials. The awl carries a spool of waxed polyester black thread on the handle. Hollow handle holds extra curved needle and wrench. Directions furnished with each awl explaining how automatic awl lock stitch can be affected in repair work. Furnished with one straight (Osborne No. 413N 8) and one curved diamond point (Osborne No. 413N 6) needle.</p> <p><i>(Osborne No.: 413; Weight: 3 ounces; UPC No. 62142)</i></p>
	Reel of Thread	<p>Osborne No. 413R</p> <p>Reel of thread 12 1/2 yards.</p>

Sign up for our monthly e-mail newsletter to receive SPECIAL DISCOUNTS!!

emaildiscounts@handrfabrics.com

H & R Fabrics
1118 North 35th Ave.
Phoenix, Arizona 85009

Mon. - Fri. 8:00 - 5:30
Saturday 9:00 - 2:00
Closed Sunday

602.269.6131
www.handrfabrics.com

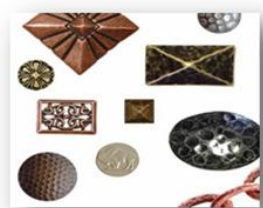

Tools Catalog

Product Picture	Name	Description
	Hand Ventilator Setter	<p>Osborne No. 621-3/4 (For setting 3/4" Ventilators.)</p> <p>1. Punch 9/16 hole in material (Use Osborne No. 149 -9/16" punch or on Vinyl, use No. 149 7/16 punch). 2. Lay ventilator neck up on base, place material over ventilator, now slip ventilator ring on bow side up. A few event taps with an Osborne Rawhide Mallet No. 196 will set ventilators.</p> <p>Osborne No. 621-1 (For setting 1" Ventilators.)</p> <p>1. Punch 3/4 hole in material (Use Osborne No. 149 -3/4" punch or on Vinyl, Use No. 149-5/8 punch). 2. Lay ventilator neck up on base, place material over ventilator, now slip ventilator ring on bow side up. A few event taps with an Osborne Rawhide Mallet No. 196 will set ventilators.</p> <p><i>(Size: 3/4; Length: 4 inches; Width: 1 inch; Weight: 14 ounces; UPC No. 64402)</i></p> <p><i>(Size: 1; Length: 4 inches; Width: 1 1/2 inch; Weight: 20 ounces; UPC No. 64404)</i></p>

Sign up for our monthly e-mail newsletter to receive SPECIAL DISCOUNTS!!

emaildiscounts@handrfabrics.com



H & R Fabrics
1118 North 35th Ave.
Phoenix, Arizona 85009

Mon. - Fri. 8:00 - 5:30
Saturday 9:00 - 2:00
Closed Sunday

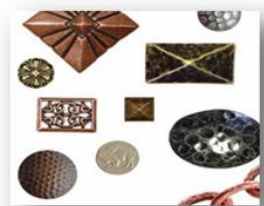
602.269.6131
www.handrfabrics.com



Tools Catalog

Product Picture	Name	Description
	Ventilators	<p>Osborne No. V-1 3/4</p> <p>Brass Plain rim ventilators used with our 621-3/4. Packed one gross.</p> <p>Osborne No. V-1 1</p> <p>Brass Plain rim ventilators used with our 621-1. Packed one gross.</p> <p><i>(Size No.: 3/4; Hole Diameter when set: 9/16; Weight per gross: 16 ounces; UPC No. 14412)</i></p> <p><i>(Size No.: 1; Hole Diameter when set: 3/4; Weight per gross: 20 ounces; UPC No. 14414)</i></p>
Knives		
	Hawkbill Knife	<p>Osborne No. 420</p> <p>This hawkbill knife is made of finest cutlery steel. Varnished hardwood handle.</p> <p><i>(Blade Length: 3 inches; Weight: 2 ounces; UPC No. 60100)</i></p>
	Auto Trimmer's and Upholsterer's Combination Knife	<p>Osborne No. 1020</p> <p>Made of finest steel with both hook and pointed blade. Used for ripping seams. Cuts auto carpeting, vinyl, plastic and rubber. Beechwood handle contoured to fit hand. A handy professional tool.</p> <p><i>(Blade Length: 2 7/8 inches; Weight: 4 ounces; UPC No. 60146)</i></p>

Sign up for our monthly e-mail newsletter to receive *SPECIAL DISCOUNTS!!*

emaildiscounts@handrfabrics.com



H & R Fabrics
1118 North 35th Ave.
Phoenix, Arizona 85009

Mon. - Fri. 8:00 - 5:30
Saturday 9:00 - 2:00
Closed Sunday

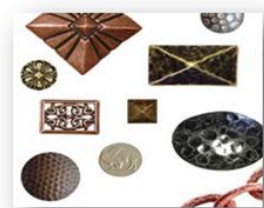
602.269.6131
www.handrfabrics.com



Tools Catalog

Product Picture	Name	Description
	Square Point Knife	<p>Osborne No. 76 1/2</p> <p>Trimmer's and upholsterer's knife. White handle. Steel blade.</p> <p><i>(Blade Length: 3 7/8 inches; Blade Width: 5/8 inches; Weight: 2 ounces; UPC No. 60046)</i></p>
General Tools		
	Upholsterers' Regulator (with eye)	<p>Osborne No. 306 1/2</p> <p>Packed 12 regulators per package.</p> <p><i>(Extra Light – Size No.: 6; Gauge: 10; UPC No. 16052)</i> <i>(Extra Light – Size No.: 8; Gauge: 10; UPC No. 16054)</i> <i>(Extra Light – Size No.: 10; Gauge: 10; UPC No. 16056)</i> <i>(Light – Size No.: 6; Gauge: 9; UPC No. 16032)</i> <i>(Light – Size No.: 8; Gauge: 9; UPC No. 16034)</i> <i>(Light – Size No.: 10; Gauge: 8; UPC No. 16036)</i> <i>(Light – Size No.: 12; Gauge: 7; UPC No. 16038)</i> <i>(Heavy – Size No.: 6; Gauge: 6; UPC No. 16042)</i> <i>(Heavy – Size No.: 8; Gauge: 5; UPC No. 16044)</i> <i>(Heavy – Size No.: 10; Gauge: 5; UPC No. 16046)</i> <i>(Heavy – Size No.: 12; Gauge: 5; UPC No. 16048)</i></p>
	Regulator (with plastic handle)	<p>Osborne No. 520</p> <p>Packed 12 regulators per package.</p> <p><i>(Length: 6 inches; UPC No. 66062)</i> <i>(Length: 8 inches; UPC No. 66064)</i> <i>(Length: 10 inches; UPC No. 66066)</i> <i>(Length: 12 inches; UPC No. 66068)</i></p>

Sign up for our monthly e-mail newsletter to receive SPECIAL DISCOUNTS!!

emaildiscounts@handrfabrics.com



H & R Fabrics
 1118 North 35th Ave.
 Phoenix, Arizona 85009

Mon. – Fri. 8:00 – 5:30
 Saturday 9:00 – 2:00
 Closed Sunday

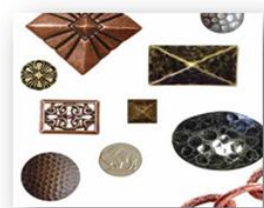
602.269.6131
www.handrfabrics.com



Tools Catalog

Product Picture	Name	Description
	Piping or Channeling Tins	<p>Osborne No. 412</p> <p>These 36" long piping tins are made of smooth aluminum. Stuffing channeling. No burs to catch on fabrics, the material is soft so tins can be bent and adjusted. Comes in three different sizes for your best convenient. Please specify size when ordering.</p> <p><i>(Size No. 2; Overall Length: 36 inches; Width: 2 inches; Weight/pr: 15 ounces, UPC No. 64362)</i></p> <p><i>(Size No. 3; Overall Length: 36 inches; Width: 3 inches; Weight/pr: 15 ounces, UPC No. 64364)</i></p> <p><i>(Size No. 4; Overall Length: 36 inches; Width: 4 inches; Weight/pr: 16 ounces, UPC No. 64366)</i></p>
	U-Cut Foam and Rubber Slicer	<p>Osborne No. 410</p> <p>U-Cut is fast, flexible and flexible. Place U-Cut on a table or on a flat surface with the slab of material to be cut. The desired cutting thickness is quickly obtained by means of an adjustable screw setting. The operator then merely pushes and pulls U-Cut in a saw-like action and, make wedges, curves, arcs and other special shapes. See illustrations. These are used particularly for orthopedic seating in autos, as well as furniture. U-Cut will cut from a minimum of 1/4" to a maximum thickness of 9". Material up to 36" in width and unlimited length can be processed. Pieces can be glue salvageable material.</p> <p><i>(Overall Length: 46 inches; Width: 17 inches; Weight: 7 1/2 pounds, UPC No. 14352)</i></p> <p><i>(Extra blades available. OSBORNE No. 410-B UPC No. 14354)</i></p>

Sign up for our monthly e-mail newsletter to receive SPECIAL DISCOUNTS!!

emaildiscounts@handrfabrics.com

H & R Fabrics
1118 North 35th Ave.
Phoenix, Arizona 85009

Mon. - Fri. 8:00 - 5:30
Saturday 9:00 - 2:00
Closed Sunday

602.269.6131
www.handrfabrics.com

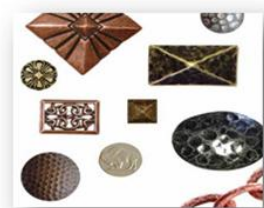

Tools Catalog

Product Picture	Name	Description
	<p>Closed End Thimble</p>	<p>Osborne No. 511</p> <p>Nickel plated brass thimbles. Coarse grate.</p> <p><i>(USA Size: 13 (00); Size: 51/64 inches; Weight: 1 ounce; UPC No. 67672)</i></p> <p><i>(USA Size: 12 (0); Size: 21/32 inches; Weight: 1 ounce; UPC No. 67674)</i></p> <p><i>(USA Size: 11 (1); Size: 3/4 inches; Weight: 1 ounce; UPC No. 67676)</i></p> <p><i>(USA Size: 10 (2); Size: 43/64 inches; Weight: 1 ounce; UPC No. 67678)</i></p> <p><i>(USA Size: 9; Size: 11/16 inches; Weight: 1 ounce; UPC No. 67682)</i></p> <p><i>(USA Size: 7; Size: 5/8 inches; Weight: 1 ounce; UPC No. 67680)</i></p>

Sign up for our monthly e-mail newsletter to receive SPECIAL DISCOUNTS!!

emaildiscounts@handrfabrics.com

H & R Fabrics
1118 North 35th Ave.
Phoenix, Arizona 85009

Mon. - Fri. 8:00 - 5:30
Saturday 9:00 - 2:00
Closed Sunday

602.269.6131
www.handrfabrics.com



Tools Catalog

Product Picture	Name	Description
	<p>Ripping Chisel</p>	<p>Osborne No. 402</p> <p>A translucent amber handle for quick identification. Perfect balance. Forged steel blade with correct angle on chisel edge. Shouldered tang, tough construction.</p> <p><i>(Blade Length: 2 3/4 inches; Overall Length: 6 3/4 inches; Weight: 5 ounces; UPC No. 53212)</i></p>

Grommets and Setters

Sign up for our monthly e-mail newsletter to receive SPECIAL DISCOUNTS!!

emaildiscounts@handrfabrics.com

H & R Fabrics
1118 North 35th Ave.
Phoenix, Arizona 85009

Mon. - Fri. 8:00 - 5:30
Saturday 9:00 - 2:00
Closed Sunday

602.269.6131
www.handrfabrics.com

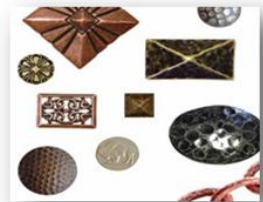

Tools Catalog

Product Picture	Name	Description
	<p>Grommet Inserting Dies</p>	<p>Osborne No. 216</p> <p>Sets plain rim washers and grommets. Sizes 00 through 5 are made from high grade tool steel, while size 6 and up are malleable iron casting. Properly machined and hardened. The finest industrial grommet die made. For best results use only Osborne grommets and washers.</p> <p><i>(Size No. 00; Weight: 1 pound, 6 ounces; UPC No. 13212)</i> <i>(Size No.: 0; Weight: 1 pound, 6 ounces; UPC No. 13214)</i> <i>(Size No.: 1; Weight: 1 pound, 7 ounces; UPC No. 13216)</i> <i>(Size No.: 2; Weight: 1 pound, 7 ounces; UPC No. 13218)</i> <i>(Size No.: 3; Weight: 1 pound, 9 ounces; UPC No. 13220)</i> <i>(Size No.: 4; Weight: 2 pounds, 8 ounces; UPC No. 13222)</i> <i>(Size No.: 5; Weight: 2 pounds, 10 ounces; UPC No. 13224)</i> <i>(Size No.: 6; Weight: 3 pounds, 15 ounces; UPC No. 13226)</i> <i>(Size No.: 10; Weight: 3 pounds, 10 ounces; UPC No. 13232)</i> <i>(Size No.: 11; Weight: 4 pounds, 15 ounces; UPC No. 13234)</i> <i>(Size No.: 15; Weight: 5 pounds, 15 ounces; UPC No. 13236)</i></p>

Sign up for our monthly e-mail newsletter to receive SPECIAL DISCOUNTS!!

emaildiscounts@handrfabrics.com

H & R Fabrics
 1118 North 35th Ave.
 Phoenix, Arizona 85009

Mon. - Fri. 8:00 - 5:30
 Saturday 9:00 - 2:00
 Closed Sunday

602.269.6131
www.handrfabrics.com

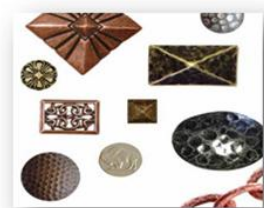

Tools Catalog

Product Picture	Name	Description
	<p>Grommet Inserting Dies</p>	<p>Osborne No. 217</p> <p>Sets spur washers and grommets. Sizes 0 through 5 are made from high grade tool steel while sizes 6, 7 & 8 are malleable iron castings. Made to U.S. Government specifications.</p> <p>(Size No.: 0; Weight: 1 pound, 6 ounces; UPC No. 13244) (Size No.: 1; Weight: 1 pound, 7 ounces; UPC No. 13246) (Size No.: 2; Weight: 1 pound, 7 ounces; UPC No. 13248) (Size No.: 3; Weight: 1 pound, 9 ounces; UPC No. 13250) (Size No.: 4; Weight: 2 pounds, 8 ounces; UPC No. 13252) (Size No.: 5; Weight: 2 pounds, 10 ounces; UPC No. 13254) (Size No.: 6; Weight: 3 pounds, 15 ounces; UPC No. 13256) (Size No.: 7; Weight: 4 pounds, 6 ounces; UPC No. 13258) (Size No.: 8; Weight: 5 pounds, 8 ounces; UPC No. 13260)</p>

Sign up for our monthly e-mail newsletter to receive SPECIAL DISCOUNTS!!

emaildiscounts@handrfabrics.com

H & R Fabrics
 1118 North 35th Ave.
 Phoenix, Arizona 85009

Mon. - Fri. 8:00 - 5:30
 Saturday 9:00 - 2:00
 Closed Sunday

602.269.6131
www.handrfabrics.com

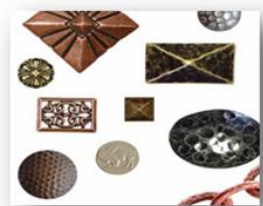

Tools Catalog

Product Picture	Name	Description
	<p>Set-It Yourself Grommet Kit</p>	<p>Osborne No. K-234</p> <p>Hang up card in an easy to use display box. Complete instructions on back of each card. For Do-It-Yourself Home Repair. Kit has grommet die, punch, cutting board and grommets. Sizes zero and one, four dozen of grommets; sizes two, three and four have two dozen of grommets. Cards measure 10-1/2 x 5".</p> <p>(Size No.: 0; Weight: 14 ounces; Grommets No.: 4dozen; UPC No. 13320) (Size No.: 1; Weight: 15 ounces; Grommet No.: 4dozen; UPC No. 13322) (Size No.: 2; Weight: 17 ounces; Grommet No.: 2dozen; UPC No. 13324) (Size No.: 3; Weight: 18 ounces; Grommet No.: 2dozen; UPC No. 13326) (Size No.: 4; Weight: 19 ounces; Grommet No.: 2dozen; UPC No. 13328)</p>

Sign up for our monthly e-mail newsletter to receive SPECIAL DISCOUNTS!!

emaildiscounts@handrfabrics.com

H & R Fabrics
 1118 North 35th Ave.
 Phoenix, Arizona 85009

Mon. - Fri. 8:00 - 5:30
 Saturday 9:00 - 2:00
 Closed Sunday

602.269.6131
www.handrfabrics.com

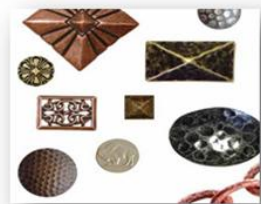

Tools Catalog

Product Picture	Name	Description
	<p>Home Grommet Inserting Kit</p>	<p>Osborne No. K235</p> <p>A complete and inexpensive kit for consumer use. Each kit consists of a No. 235 grommet die, a No. 245 cutting punch, three dozen brass plain rim grommets and washers, a small cutting board and complete instructions. Packed in a caseboard box.</p> <p><i>(Size No.: 0; Grommet Diameter: 1/4 inches; Kit Weight: 1 1/4 pounds; UPC No. 13294)</i> <i>(Size No.: 1; Grommet Diameter: 9/32 inches; Kit Weight: 1 1/2 pounds; UPC No. 13296)</i> <i>(Size No.: 2; Grommet Diameter: 3/8 inches; Kit Weight: 1 3/4 pounds; UPC No. 13298)</i> <i>(Size No.: 3; Grommet Diameter: 7/16 inches; Kit Weight: 1 3/4 pounds; UPC No. 13300)</i> <i>(Size No.: 4; Grommet Diameter: 1/2 inches; Kit Weight: 1 3/4 pounds; UPC No. 13302)</i></p>

Sign up for our monthly e-mail newsletter to receive SPECIAL DISCOUNTS!!

emaildiscounts@handrfabrics.com

H & R Fabrics
 1118 North 35th Ave.
 Phoenix, Arizona 85009

Mon. - Fri. 8:00 - 5:30
 Saturday 9:00 - 2:00
 Closed Sunday

602.269.6131
www.handrfabrics.com